

Genie® GTH™ -5519

Specifications

Models	GTH-5519	
Measurements	US	METRIC
Maximum lift height	18 ft 10 in	5.74 m
Maximum forward reach	11 ft 3 in	3.43 m
Reach at maximum height	1 ft 10 in	0.56 m
A Height, stowed	6 ft 6 in	1.98 m
B Length, stowed (without forks)	12 ft 3 in	3.73 m
Width	5 ft 11 in	1.80 m
C Wheelbase	7 ft 6 in	2.29 m
D Ground clearance, center	1 ft 2 in	0.36 m
E Ground clearance, axle	10 in	0.25 m
Fork cross section	1.6×4 in	40×100 mm

Productivity

Maximum lift capacity	5,500 lb	2,495 kg
Lift capacity at maximum height	4,400 lb	1,996 kg
Lift capacity at maximum reach	1,900 lb	862 kg
Drive speed	15 mph	24 km/h
Draw bar pull/ Break out force	10,250 lb	4,649 kg
Frame leveling (side to side)		10°
Turning radius, outside (4WS)	11 ft	3.35 m
Auxiliary hydraulic flow	17 gpm	64 lpm
Auxiliary hydraulic pressure	3,918 psi	270 bar
Tires, standard size	12×16.5 in, 10 ply	0.30×0.42 m, 10 ply

Power

Power source	Diesel	
Electrical system voltage	12V	
Alternator	Deutz TCD 2.9 - 95 amp	
Battery	720 CCA 0°F (-18°C)	
Hydraulic tank capacity	18.5 gal	70 L
Hydraulic system capacity (w/tank)	31.7 gal	120 L
Fuel tank capacity	15.8 gal	59.8 L

Weight

Weight*	10,360 lb	4,700 kg
---------	-----------	----------

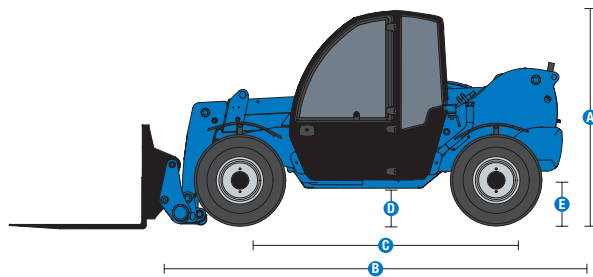

Range of motion GTH-5519

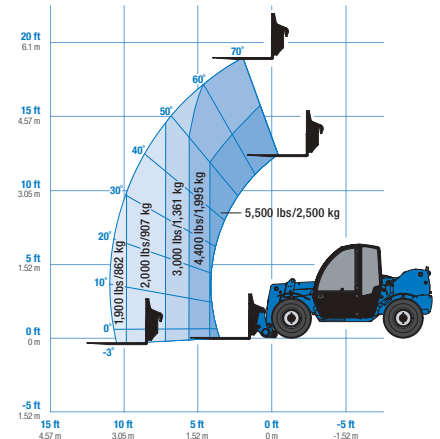

(1) Weight will vary depending on options and/or country standards.
 (2) Load ratings vary depending on attachment.

Genie® GTH™ -5519

SKU: Standard Model

- **GTH55191AF0112:** GTH-5519, 74 hp, Open cab
- **GTH55191AF0152:** GTH-5519, 74 hp, Closed cab w/ heater
- **GTH55191AF0151:** GTH-5519, 74 hp, Closed cab w/ AC and heater

* Build to Order

Option availability	S	S+	BtO
Cab			
Open cab ROPS/FOPS canopy	✓	✓	○
Closed cab: Heater, defrost, wipers, washer, split door			○
Closed cab: AC, heater, defrost, wipers, washer, split door			○
Front and top glass		○	○
Rear Proximity Alarm		○	○
Fire extinguisher		○	○
3in/7.6cm high visibility red retractable seat belt	✓	✓	✓
Adjustable suspended seat	✓	✓	✓
Backup alarm	✓	✓	✓
Full gauge cluster with engine diagnostics	✓	✓	✓
Fully proportional boom and auxiliary hydraulic controls	✓	✓	✓
Machine level indicator	✓	✓	✓
Mirrors - LH canopy mounted and RH chassis mounted	✓	✓	✓
Multi-function joystick controller	✓	✓	✓
Power steering	✓	✓	✓
RH steel mesh screen	✓	✓	✓
Tilt steering wheel	✓	✓	✓
Top glass	✓	✓	✓
Chassis			
74 hp, Deutz TCD 2.9, T4f, Side-mounted engine	✓	✓	✓
Lift Connect Telematics		○	○
Lift Connect with Access Manager upgrade		○	○
Telematics-ready	✓	✓	✓
Brick guard		○	○
Electric oil pan heater			○
Fenders set of four		○	○
Lojack stolen vehicle recovery system			○
Positive air shutdown system			○
Flashing Beacon		○	○
Work lights: High output LED cab, boom, rear		○	○
Road and work lights: High output LED front, cab, boom, rear		○	○
Air-filled non-marking tires		○	○
Air-filled rough terrain tires		○	○
Air-filled turf tires		○	○
Foam-filled rough terrain tires		○	○
Solid rough terrain tires		○	○
3-mode steering (2-wheel, 4-wheel and crab) with limited slip front differential	✓	✓	✓
Cold start intake glow plugs	✓	✓	✓
Full time 4WD with front limited split differential	✓	✓	✓
Internal multiple wet disc brakes	✓	✓	✓
Spring applied, hydraulic release parking brake	✓	✓	✓
Variable speed hydrostatic drive	✓	✓	✓
Boom			
Genie manual Quick-Attach	✓	✓	✓
Genie hydraulic Quick-Attach (QA) system			○
Auxiliary hydraulic circuit (18.5 GPM)	✓	✓	✓
Boom angle indicator	✓	✓	✓
Lifting shackle at boom tip	✓	✓	✓
Self-leveling fork frame	✓	✓	✓
Attachment			
QA Carriage, 48in/1.2m		○	○
QA Side shift carriage, 48in/1.2m (4in/.1m R/L)		○	○
QA Side tilt (rotating) carriage, 48in/1.2m		○	○
Universal skid steer adapter		○	○
QA Bucket, bolt-on cutting edge, 66in/1.67m (.5/.65yd3)		○	○
QA Scrap grapple bucket, 78in/1.9m (.68/.83yd3)		○	○
QA Truss boom, 6ft/1.83m, 2000lb/907kg		○	○
Pallet forks, 48in (1.75×4×48in)/(.04x.1×1.2m) - set of 2		○	○
Pallet forks, 60in (2×4×60in)/(.05x.1×1.5m) - set of 2		○	○
Cubing tines, 48in (2×2×48in)/(.05x.05×1.2m) - set of 4		○	○

- S Standard
- S+ Standard +
- BtO Build to Order
- ✓ Standard Features
- Options



Compact Footprint



Lift Shackle



Material Handling Attachments



Other Accessories⁽¹⁾

- Fire extinguisher

(1) More accessories available from Genie Genuine Parts.

Product specifications are subject to change without notice or obligation. Photographs and/or drawings herein are for illustrative purposes only. Refer to the appropriate Operator's Manual for instructions on proper equipment use. Failure to follow instructions in the Operator's Manual may result in serious injury or death. The only warranty applicable to our equipment is the standard written warranty applicable to the particular product and sale and we make no other warranty, express or implied. Products and services listed may be trademarks, service marks or trade names of Terex Corporation and/or their subsidiaries in the USA and many other countries. Terex, Genie, Quality By Design, Xtra Capacity, Lift Power, Lift Guard, Lift Tools, Lift Connect and Tech Pro Link are registered trademarks of Terex Corporation or its subsidiaries.