

# Genie® Z<sup>®</sup>-62/40 & Z-62/40 TraX™

## Specifications

Models	Z-62/40 & Z-62/40 TraX	
Measurements	US	Metric
Working height max. <sup>(1)</sup>	67 ft 11 in	20.87 m
Working height max. (TraX) <sup>(1)</sup>	68 ft 1 in	20.92 m
Platform height max.	61 ft 11 in	18.87 m
Platform height max. (TraX)	62 ft 1 in	18.92 m
Horizontal reach max.	40 ft 9 in	12.42 m
Below ground reach	8 ft 1 in	2.46 m
Up and over clearance max.	25 ft 7 in	7.8 m
<b>A</b> Platform length (8 ft/6 ft)	3 ft/2 ft 6	0.91 m/0.76 m
<b>B</b> Platform width (8 ft/6 ft)	8 ft/6 ft	2.44 m/1.83 m
<b>C</b> Height - stowed (tires)	8 ft 4 in	2.54 m
<b>C</b> Height - stowed (TraX)	8 ft 11 in	2.72 m
<b>C</b> Height storage/transport height (jib tucked under - Tires/TraX)	9 ft 6 in/9 ft 5 in	2.90 m/2.87 m
<b>D</b> Length - stowed (tires)	24 ft 10 in	7.57 m
<b>D</b> Length - stowed (TraX)	32 ft	9.75 m
<b>D</b> Length - storage/transport (jib tucked under - Tires/TraX)	24 ft 5 in/25 ft 5 in	7.44 m/7.75 m
<b>E</b> Width	8 ft 2 in	2.49 m
<b>E</b> Width (TraX)	8 ft 1.6 in	2.48 m
<b>F</b> Wheelbase	8 ft 2 in	2.49 m
<b>G</b> Ground clearance - center (tires)	1 ft 3 in	0.38 m
<b>G</b> Ground clearance - center (TraX)	1 ft 6.6 in	0.47 m

## Productivity

Lift capacity max. - unrestricted	500 lb	227 kg
Platform rotation	160°	
Jib length	5 ft	1.52 m
Vertical jib rotation	135°	
Turntable rotation	360°	
Turntable tailswing	zero	
Drive speed - stowed (tires) <sup>(2)</sup>	3.0 mph	4.8 km/h
Drive speed - stowed (TraX)	2.3 mph	3.7 km/h
Drive speed - raised (tires)	0.70 mph	1.1 km/h
Drive speed - raised (TraX)	0.70 mph	1.1 km/h
Gradeability - stowed <sup>(2)</sup>	30%	45%
Tilt sensor activation (front to back/side to side)	4.5° / 4.5°	
Turning radius - inside/outside (tires, 4WD)	4 ft 5 in/11 ft 11 in	1.30 m/3.60 m
Turning radius - inside/outside (TraX)	8 ft 0.5 in/18 ft 5 in	2.45 m/5.60 m
Tires (solid, non-marking)	355/55 D625	

## Power

Power	Diesel	
Auxiliary power unit	12V DC	
Hydraulic tank capacity	35 gal	132 L
Fuel tank capacity	36 gal	136 L

## Weight<sup>(3)</sup> and Floor Loading<sup>(4)</sup>

Weight, 2WS	22,160 lb	10,052 kg
Weight, 4WS	22,665 lb	10,281 kg
Weight (TraX)	26,933 lb	12,217 kg
Tire contact pressure	70 psi	483 kPa
Track contact pressure	12.5 psi	86 kPa
Occupied floor pressure (tires)	265 psf	12.71 kPa
Occupied floor pressure (TraX)	265 psf	12.71 kPa

## Sound and Vibration Levels

Sound Pressure level (ground workstation)	86 dBA	
Sound Pressure level (platform workstation)	75 dBA	
Vibrations	8 ft 2 in/s <sup>2</sup>	2.5 m/s <sup>2</sup>

## Range of motion Z-62/40 & Z-62/40 TraX

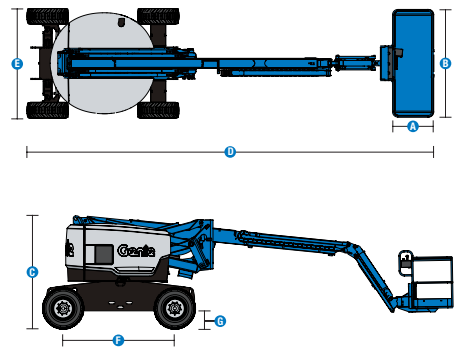
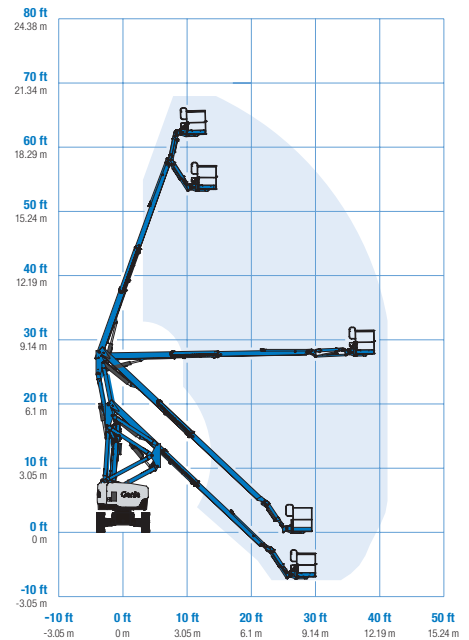

(1) The metric equivalent of working height adds 2 m to platform height. The imperial equivalent adds 6 ft to platform height.  
 (2) Gradeability applies to driving on slopes and may vary depending on options and machine configurations. See operator's manual for details regarding slope ratings.  
 (3) Weight refers to standard configuration and may vary depending on options and/or country standards.  
 (4) Floor loading information is approximate and may vary depending on options and machine configurations. It should be used only with adequate safety factors.

# Genie® Z<sup>®</sup>-62/40 & Z-62/40 TraX™

## SKU: Standard Model

- **Z6200001CV0006:** Z-62/40, 110V, 4WD
- **Z6200001CV0007:** Z-62/40, 220V, 4WD
- **Z6200001CV0008:** Z-62/40, Stage IIIA, 220V, 4WD



\* Build to Order

## SKU: Standard Model

- **Z6200001CV0005:** Z-62/40, 110V, 3kW AC Generator, 4WD
- **Z6200001CV0024:** Z-62/40, 220V, 3kW AC Generator, 4WD
- **Z6200001AF0004:** Z-62/40 TraX 60 hp, Deutz Turbo Diesel

Option availability		S	S+	BtO
Power	48 hp, 35.8 kW, Deutz D2011, Diesel, T4i/Stage IIIA			○
	49 hp, 36 kW, Deutz TD2.2L, Turbo Diesel, Stage V	✓	✓	✓
	60 hp, 45 kW, Deutz TD2.2L, Turbo Diesel, Stage V (TraX only)	✓	✓	✓
	Cold weather package		○	○
	Diesel air intake pre-cleaner			○
	Diesel catalytic scrubber muffler (T4i/Stage IIIA)			○
	Engine gauge package	✓	✓	✓
	Positive air shutdown system			○
	Auto engine fault shutdown	✓	✓	✓
Platform	6ft/1.83m dual-entry platform with side swing gate			○
	8ft/2.44m tri-entry platform with side swing gate	✓	✓	✓
	Power to platform, no RCBO	✓	✓	✓
	Power to platform with RCBO		○	○
	Air line to platform			○
	Control box covers		○	○
	Lift Guard Full Mesh panels			○
	Lift Guard Half Mesh panels			○
	Light Package: drive and work lights			○
	Platform auxiliary top rail			○
	Platform level cutout		○	○
	3kW AC Generator, 110V/50Hz			○
	3kW AC Generator, 220V/50Hz			○
	5ft/1.52m Jib	✓	✓	✓
	AC Power cord to platform	✓	✓	✓
	Alarm package: flashing beacons, descent, travel and tilt alarms	✓	✓	✓
	Drive enable system	✓	✓	✓
	Horn	✓	✓	✓
	Lift Guard Contact Alarm	✓	✓	✓
	Lift Tools Work Tray	✓	✓	✓
Platform load sense system	✓	✓	✓	
Proportional controls	✓	✓	✓	
Self-leveling platform	✓	✓	✓	
Chassis	Lift Connect Telematics		○	○
	Telematics-ready	✓	✓	✓
	Lift Connect with Access Manager upgrade		○	○
	Eco32 biodegradable hydraulic oil			○
	Rough terrain, foam-filled tires	✓	✓	✓
	Rough terrain, foam-filled, non-marking tires			○
	TraX track drive system			○
	2 wheel steering	✓	✓	✓
	4 wheel steering			○
	Chassis tilt lift and drive function cut-out		○	○
	2 speed wheel motors	✓	✓	✓
	Active oscillating axle	✓	✓	✓
	Chassis tilt drive function cut-out	✓	✓	✓
Dual parallelogram lift linkage	✓	✓	✓	
Hour meter	✓	✓	✓	
Hydraulic oil cooler	✓	✓	✓	

Positive air shutdown Stage V engines only  
 Engine gauge package standard on Stage IIIA engine

 S	Standard
 S+	Standard +
 BtO	Build to Order
✓	Standard Features
○	Options



Zero Tailswing



45% Rugged Terrainability



Genie FastMast



### Genie Genuine Accessories<sup>(1)</sup>

- Lift Tools Productivity Tools
- Lift Connect Telematics
- Tech Pro Link Handheld Device

(1) More accessories available from Genie Genuine Parts.

Product specifications are subject to change without notice or obligation. Photographs and/or drawings herein are for illustrative purposes only. Refer to the appropriate Operator's Manual for instructions on proper equipment use. Failure to follow instructions in the Operator's Manual may result in serious injury or death. The only warranty applicable to our equipment is the standard written warranty applicable to the particular product and sale and we make no other warranty, express or implied. Products and services listed may be trademarks, service marks or trade names of Terex Corporation and/or their subsidiaries in the USA and many other countries. Terex, Genie, Quality By Design, Xtra Capacity, Lift Power, Lift Guard, Lift Tools, Lift Connect and Tech Pro Link are registered trademarks of Terex Corporation or its subsidiaries.